



HIRSCHMANN

A **BELDEN** BRAND

FiberINTERFACES



**The right solution for all network requirements at the field level:
FiberINTERFACES from Hirschmann™.**

Highlights at a glance: Fiber optic solutions from Hirschmann™

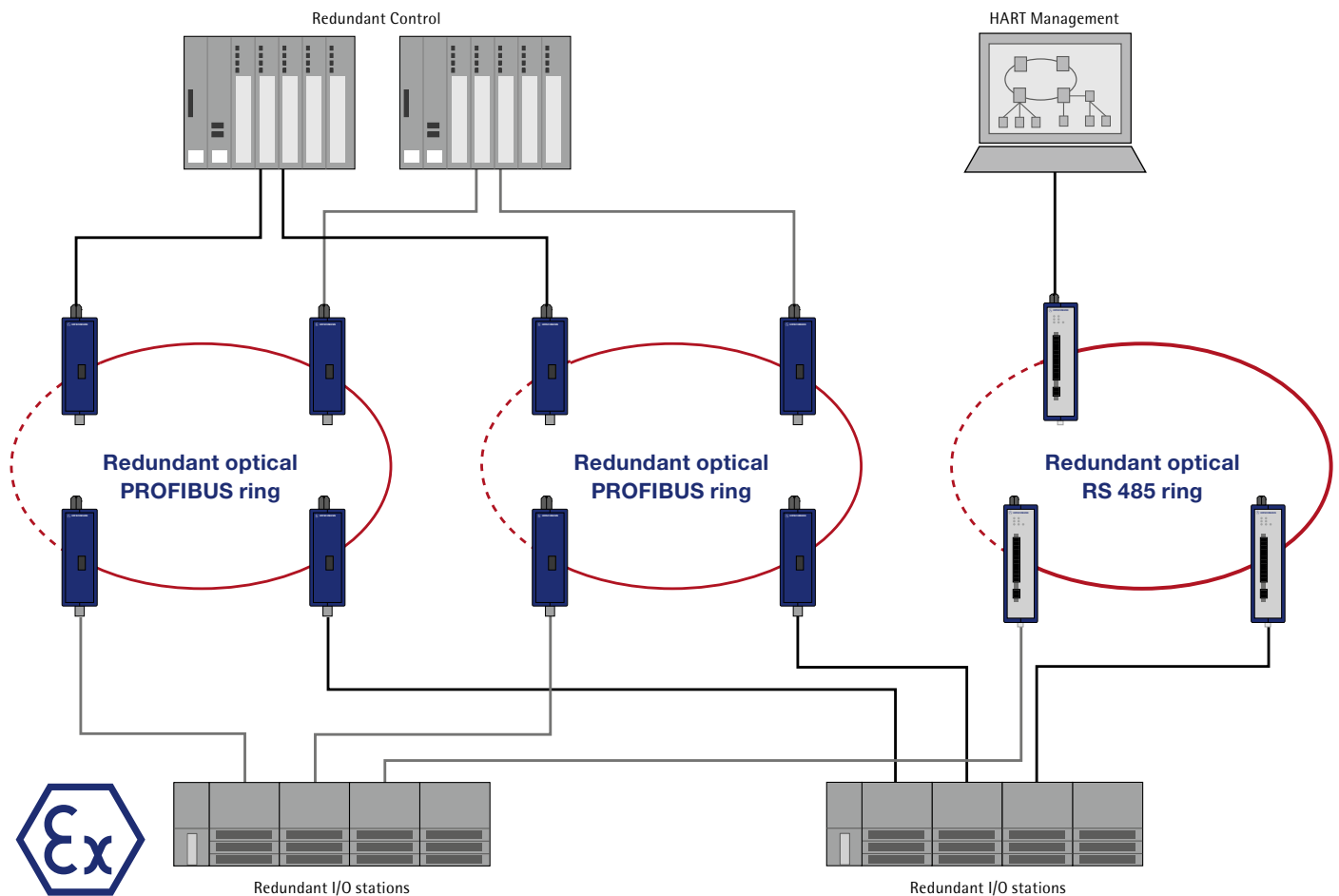

Example of a highly available network in oil production

Fieldbus fiber optic cable repeater

Hirschmann™ has developed industrial fiber optic cable repeaters for current fieldbus protocols. Even with extreme electromagnetic interference, they ensure secure, reliable transmission of fieldbus signals. In widespread plants, the fiber optic cables' insulation characteristics provide natural lightning protection – thus increasing the plant's operational safety. The repeaters are engineered for harsh application conditions, for instance, in chemical plants or in oil production. And, they also have required ATEX, UL, FM and NEPSI certifications.

Serial media converter

The compact plug-on modules from Hirschmann™ are ideal for secure, interference-free transmission of classic V.24 interface signals – even under challenging environmental conditions and over long distances. Fiber optic cables eliminate EMC risks, thus reducing the risk of an operational shutdown.



Profibus repeater with diagnosis signals for predictive maintenance

OZD PROFIBUS 12M P11 PRO	OZD PROFIBUS 12M P12 PRO	OZD PROFIBUS 12M G11 PRO	OZD PROFIBUS 12M G12 PRO	OZD PROFIBUS 12M G12 EEC PRO	OZD PROFIBUS 12M G11-1300 PRO	OZD PROFIBUS 12M G12-1300 PRO	OZD PROFIBUS 12M G12 1300 EEC PRO
943 904-221	943 904-321	943 905-221	943 905-321	943 907-321	943 906-221	943 906-321	943 908-321
1 electrical, 1 optical port, predictive maintenance, for plastic optical fiber POF	1 electrical, 2 optical ports, predictive maintenance, for plastic optical fiber (POF), redundant optical ring	1 electrical, 1 optical port, predictive maintenance, multimode	1 electrical, 2 optical ports, predictive maintenance, multimode, redundant optical ring	1 electrical, 2 optical ports, predictive maintenance, multimode, redundant optical ring, EEC*	1 electrical, 1 optical port, predictive maintenance, singlemode	1 electrical, 2 optical ports, predictive maintenance, singlemode, redundant optical ring	1 electrical, 2 optical ports, predictive maintenance, singlemode, redundant optical ring, EEC*









Profibus repeater with ATEX Zone 2, FM Class 1, Div. 2 and NEPSI Zone 2 certifications







OZD PROFIBUS 12M P11	OZD PROFIBUS 12M P12	OZD PROFIBUS 12M G11	OZD PROFIBUS 12M G12	OZD PROFIBUS 12M G12 EEC	OZD PROFIBUS 12M G11 1300	OZD PROFIBUS 12M G12 1300	OZD PROFIBUS 12M G12 1300 EEC
943 728-221	943 728-321	943 727-221	943 727-321	943 730-321	943 729-221	943 729-321	943 256-321
For plastic optical fiber (POF), 1 electrical, 1 optical port	For plastic optical fiber (POF), 1 electrical, 2 optical ports, redundant optical ring	1 electrical, 1 optical port, multimode	1 electrical, 2 optical ports, multimode, redundant optical ring	1 electrical, 2 optical ports, multimode, redundant optical ring, EEC*	1 electrical, 1 optical port, singlemode	1 electrical, 2 optical ports, singlemode, redundant optical ring	1 electrical, 2 optical ports, singlemode, redundant optical ring, EEC*

Profibus repeater with ATEX Zone 1 certification			Profibus plug-on repeater	
OZD PROFIBUS G12DU ATEX 1	OZD PROFIBUS G12DK ATEX 1	OZD PROFIBUS G12DE ATEX 1	OZD ProfiPlug P11	OZD ProfiPlug P21
943 881-321	943 882-321	943 883 -321	943 924-221	943 924-321
1 electrical, 2 optical ports, predictive maintenance, multimode, redundant optical ring, for mounting in ATEX-certified housing	1 electrical, 2 optical ports, predictive maintenance, multimode, redundant optical ring, for mounting in stainless steel IP67 ATEX-certified housing	1 electrical, 2 optical ports, predictive maintenance, multimode, redundant optical ring, for mounting in stainless steel IP67 ATEX-certified housing	1 electrical, 1 optical port, bus-powered, POF 0-75 m, HCS 0-100 m	2 electrical, 1 optical port, bus-powered, POF 0-75 m, HCS 0-100 m





RS 485 repeater			RS 232 media converters				
OZD 485 G12 BASIC	OZD 485 G12 PRO	OZD 485 G12-1300 PRO	OZDV 2451P	OZDV 2451G	OZDV 2471P	OZDV 2471G	OZDV 2471G-1300
							
943 893-321	943 894-321	943 895-321	943 316-021	943 299-021	943 340-021	943 341-021	933 990-021
1 electrical, 2 optical ports, multimode, optical line	1 electrical, 2 optical ports, predictive maintenance, multimode, redundant optical ring	1 electrical, 2 optical ports, predictive maintenance, singlemode, redundant optical ring	1 electrical, 1 optical port bus-powered, POF 0–60 m	1 electrical, 1 optical port bus-powered, multimode, 0–2000 m	1 electrical, 1 optical port, POF 0–100 m, HCS 0–2100 m	1 electrical, 1 optical port, multimode, 0–6700 m	1 electrical, 1 optical port, singlemode, 0–32000 m

Geniusbus repeater		Modbus Plus repeater		WorldFIP repeater	
OZD GENIUS G12	OZD GENIUS G12 1300	MODBUS PLUS G12	MODBUS PLUS G12 1300	OZD FIP G3	OZD FIP G3 T
					
933 989-021	934 233-021	943 740-021	943 821-021	933 847-321	933 847-521
1 electrical, 2 optical ports, redundant optical ring	1 electrical, 2 optical ports, singlemode, redundant optical ring	1 electrical, 2 optical ports, redundant optical ring	1 electrical, 2 optical ports, singlemode, redundant optical ring	1 electrical, 2 optical ports, predictive maintenance, multimode, redundant optical ring	1 electrical, 2 optical ports, predictive maintenance, multimode, redundant optical ring, integrated bus termination

*NOTE:
Devices marked with EEC identification can operate in atmospheric conditions with 100% relative humidity



Reaching your goal with fiber optic technology – even under extreme ambient conditions.

As an experienced manufacturer of industrial network components for factory, process and transport automation, Hirschmann™ also offers leading-edge solutions in the field of fiber optics – for process control and traffic routing as well as for the energy sector.

A key benefit is that fiber optic cables are ideally suited for reliable data transmission over long distances and are completely insensitive to even the most extreme electromagnetic interference. They can be connected directly to powerful motors or laid parallel to high-power cables in extremely harsh electrical environments. In areas subject to risk of explosion, fiber optic cables, in combination with ex-certified media converters, are ideal data-transmission cables, since they will not cause an explosion, even when severely damaged.

Fiber optic products and solutions from Hirschmann™ meet even the most demanding transmission challenges securely and reliably – from long distances at the field level to Zone 1 hazardous areas.

With its HEW-KABEL, Hirschmann™ and Lumberg Automation™ brands, Belden offers a wide range of solutions and is the right partner for your fiber optic applications. Please contact us to discuss your specific requirements!

More at:

www.belden.com/industrial

www.hewkabel.de

www.hirschmann.de

www.lumbergautomation.de





HIRSCHMANN

A BELDEN BRAND

www.hirschmann.com

GLOBAL LOCATIONS

For worldwide Industrial Sales
and Technical Support, visit:
www.belden.com/industrial



EUROPE

Headquarters – Germany
Hirschmann Automation and
Control GmbH
Phone: +49 7127 14-0
Fax: +49 7127 14-1542
INET-sales@hirschmann.de
[web: www.hirschmann.com](http://www.hirschmann.com)

Regarding the details in this brochure: The information/details in this publication merely contain general descriptions or performance factors which, when applied in an actual situation, do not always correspond with the described form, and may be amended by way of the further development of products. The desired performance factors shall only be deemed binding if these are expressly agreed on conclusion of the contract. Please note that some characteristics of the recommended accessory parts may differ from the appropriate product. This might limit the possible operating conditions for the entire system.